

SAMSUNG Flip

Libérez vos réunions !



installer



démarrer



bouger



présenter



noter



partager



effacer



sauvegarder



envoyer

Specifications techniques

Dispositif Flip			
Dalle	Diagonale	55"	
	Type	60Hz E-LED	
	Résolution	"3,840 x 2,160 (paysage) 2,160 x 3,840 (Portrait)"	
	Luminosité	Max 350cd/m ² (sans le verre), 220cd/m ² (avec le verre)	
	Contraste	4700:1	
	Angles de vision	178:178	
	Temps de réponse	8ms	
Son	Type de Haut-parleur	Haut-parleurs intégrés (10W x 2)	
Connectiques	ENTRÉE	RGB	-
		VIDEO	HDMI 1
		AUDIO	-
		USB	USB 2 (ver 2.0x2, Side 1, Sensor Assy1)
	SORTIE	RGB	-
		VIDEO	-
		AUDIO	-
		Touch Out	Touch Out 1 (Side, USB Upstream Type)
	INTERNE	Capteurs	NFC, Accéléromètre, Capteur de proximité
	EXTERNE	CONTRÔLE	RJ45
Tactile	Type	InGlass	
	# de stylet écran	4	
	Type stylet tactile	Stylet Passif	
	Gamme de reconnaissance objet	2mm/ 4mm / 8mm / 50mm	
	Réponse Tactile	"38ms ~ 46ms (Selon le nombre de contact écran)"	
Électrique	Type	Interne	
	Alimentation	AC 100~240V 50/60Hz	
	Consommation énergétique	Max[W/h]	165
		Moyen[W/h]	100
		Rating[W/h]	150
		Veille[W/h]	0.5
BTU[W/h]		562.65	
Caractéristiques physiques	Dimension (mm)	Nette	1302.6(L) * 805.5(H) * 52.0(P)
		Emballage	1469(L) * 924(H) * 210(P)
	Poids (kg)	Nette	28.9
		Emballage	34.9
	Couleur	Gris Clair	
	VESA	400 x 400	
Verre de Protection	Oui		
Pied	Pied Mobile(Acc), Plateau		
Option Player Média	N/A		
Rotation	"Disponible avec le pied du Flip		
Longueur câble alimentation	3m		
Accessoire	Cover-Jack		
Environnement	Température de fonctionnement	0°C~ 40°C	
	Humidité	10~80%	
Produit	Référence	LH55WMHPTWC/EN EAN 880 164 304 74 81	

Specifications techniques

Dispositif Flip			
Fonctionnalités	Spécial	H/W	Capteur Thermique, Ecran Pivotable, Haut-Parleurs Intégrés(10W x 2), Module WiFi intégré
		S/W	Flip S/W
	Player Interne	Plateforme	Kant-M (Tizen 3.0)
		Processeur	CA72 Quad(1.7GHz)
		Mémoire Cache Embarqué	"L1 (I/D) : 32KB / 32KB L2 (Unified) : 1MB"
		Vitesse exécution	1.7GHz CPU Quad
		RAM	LPDDR4 1400MHz 64bit 3GB
		Graphique	"2D & 3D Graphics Engine - Jusqu'à 1920x1080. 32bpp - Supporte OpenGL ES"
		Stockage	8GB
		Multimédia	" *Video Decoder : MPEG-1/2/4, H.263, H.264/AVC, UHD H.264/AVC, VC-1, AVS+, HEVC, JPEG, PNG, VP8, VP9 *Audio Decoder : AC3 (DD), MPEG"
Accessoires	Optionnel	Inclus	Stylet, Câble d'alimentation, Câble Touch Out
		Pied	STN-WM55H/EN EAN 880 164 310 66 07

Pied Flip			
Caractéristiques physiques	Dimension (mm)	Nette	1023 x 1611 x 991 mm
		Emballage	31.7 kg
	Poids (kg)	Nette	1,682 x 221 x 1,038 mm
		Package	41.8 kg
		Couleur	Gris clair
		VESA	400 X 400
Connectiques	Rotation	Rotation à 90°	
Accessoires	Connectique étendue	1 HDMI / 1 Touch Out / 1 RJ45 / 1 câble d'alimentation	
Fonctionnalités	Inclus	Guide d'Installation	
	Spécial	H/W	Rotation(4-roues) / Pivot(90°) / Support Plateau(Arrière)

Guide d'installation

Guide d'installation rapide

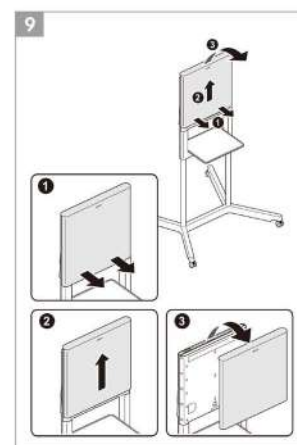
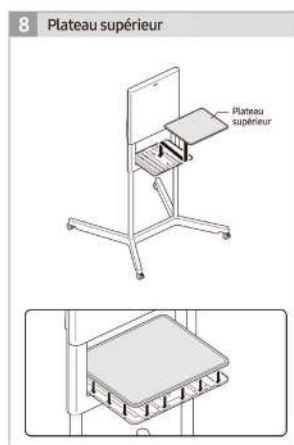
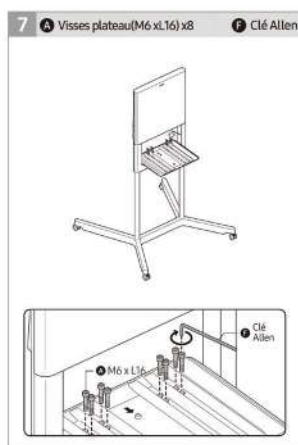
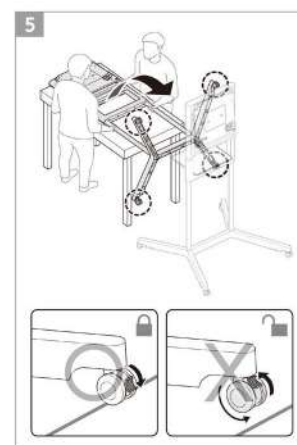
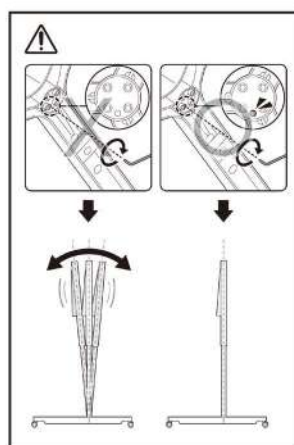
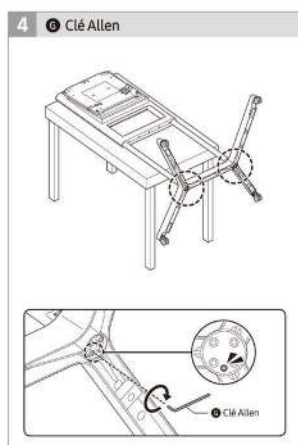
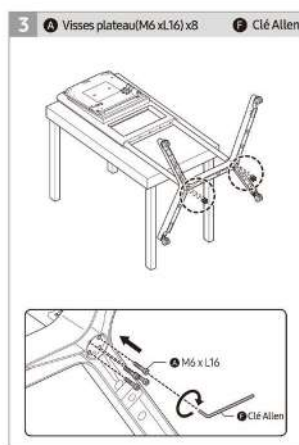
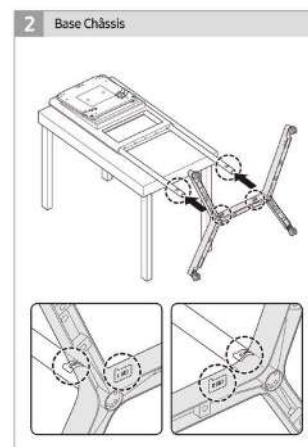
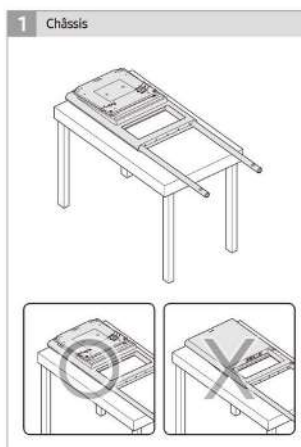
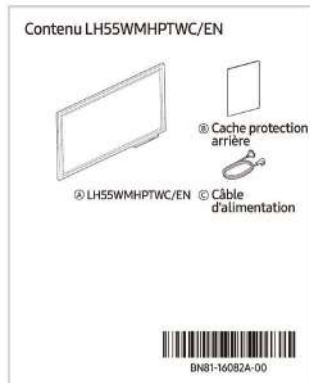
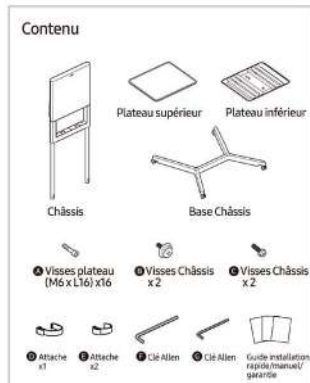

Guide d'installation

